

SIRUBA®

銀爺牌工業用縫紉機

INDUSTRIAL SEWING MACHINE

T828

零件圖 PARTS LIST

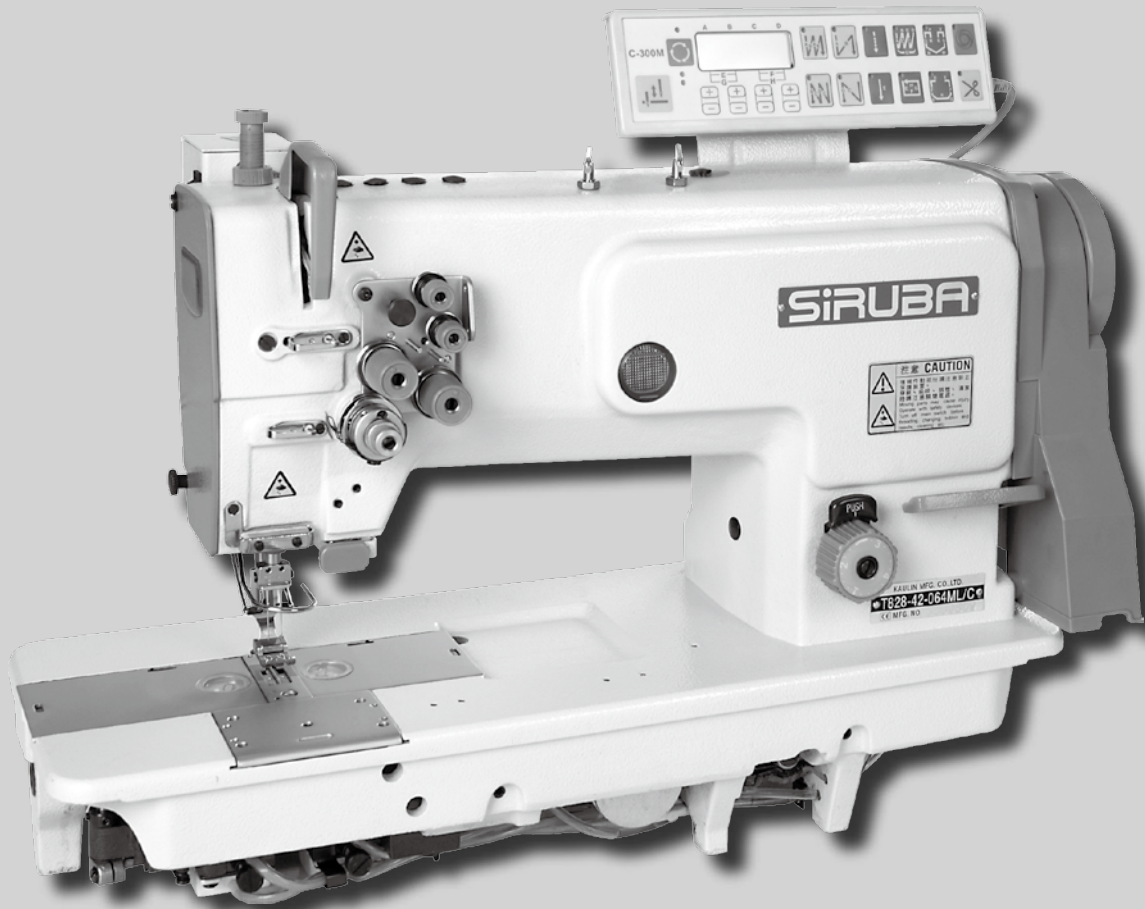

CE



高林股份有限公司
KAULIN MFG. CO., LTD.

									
MODEL	OPERATING PANEL	SUB-CLASS	NEEDLE PLATE	FEED DOG	NEEDLE CLAMP	PRESSER FOOT	HOOK	BOBBIN	NEEDLE
機 型	操作盒	規 格	針 板	下送具	針 釧	押 具	旋 梭	梭 子	針 號
T828-42-032ML		1/8" (3.2)	E734	D734/P	M734	P734/S	G161	G307	DPX5#14
T828-42-048ML		3/16" (4.8)	E736	D736/P	M736	P736/S	G161	G307	DPX5#14
T828-42-064ML		1/4" (6.4)	E730	D730/P	M730	P730/S	G161	G307	DPX5#14
T828-42-032M		1/8" (3.2)	E734	D734/P	M734	P734/S	G162-A (G162+G406)	G307	DPX5#14
T828-42-048M		3/16" (4.8)	E736	D736/P	M736	P736/S	G162-A (G162+G406)	G307	DPX5#14
T828-42-064M		1/4" (6.4)	E730	D730/P	M730	P730/S	G162-A (G162+G406)	G307	DPX5#14
T828-42-032HL		1/8" (3.2)	E762	D734/P	M734	P734/S	G167	G307	DPX5#22
T828-42-048HL		3/16" (4.8)	E761	D736Q	M736	P736/S	G167	G307	DPX5#22
T828-42-064HL		1/4" (6.4)	E760	D730Q	M730	P730/S	G167	G307	DPX5#22
T828-42-032H		1/8" (3.2)	E762	D734/P	M734	P734/S	G162-A (G162+G406)	G307	DPX5#22
T828-42-048H		3/16" (4.8)	E761	D736Q	M736	P736/S	G162-A (G162+G406)	G307	DPX5#22
T828-42-064H		1/4" (6.4)	E760	D730Q	M730	P730/S	G162-A (G162+G406)	G307	DPX5#22
T828-42-032ML/C	C300M-A2	1/8" (3.2)	E754-A	D754	M734	P754/S	G163	G307	DPX5#14
T828-42-048ML/C	C300M-A2	3/16" (4.8)	E766-A	D766	M736	P766/S	G163	G307	DPX5#14
T828-42-064ML/C	C300M-A2	1/4" (6.4)	E745-A	D745	M730	P745/S	G163	G307	DPX5#14
T828-42-032M/C	C300M-A2	1/8" (3.2)	E754-A	D754	M734	P754/S	G164-A (G164+G406)	G307	DPX5#14
T828-42-048M/C	C300M-A2	3/16" (4.8)	E766-A	D766	M736	P766/S	G164-A (G164+G406)	G307	DPX5#14
T828-42-064M/C	C300M-A2	1/4" (6.4)	E745-A	D745	M730	P745/S	G164-A (G164+G406)	G307	DPX5#14







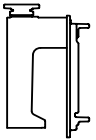

規格件表 CONVERSION CHART

									
MODEL	OPERATING PANEL	SUB-CLASS	NEEDLE PLATE	FEED DOG	NEEDLE CLAMP	PRESSER FOOT	HOOK	BOBBIN	NEEDLE
機 型	操作盒	規 格	針 板	下送具	針 釗	押 具	旋 梭	梭 子	針 號
T828-42-032HL/C	C300M-A2	1/8" (3.2)	E788-A	D788D	M734	P754/S	G163	G307	DPX5#22
T828-42-048HL/C	C300M-A2	3/16" (4.8)	E787-A	D787D	M736	P766/S	G163	G307	DPX5#22
T828-42-064HL/C	C300M-A2	1/4" (6.4)	E786-A	D786D	M730	P745/S	G163	G307	DPX5#22
T828-42-032H/C	C300M-A2	1/8" (3.2)	E788-A	D788D	M734	P754/S	G164-A (G164+G406)	G307	DPX5#22
T828-42-048H/C	C300M-A2	3/16" (4.8)	E787-A	D787D	M736	P766/S	G164-A (G164+G406)	G307	DPX5#22
T828-42-064H/C	C300M-A2	1/4" (6.4)	E786-A	D786D	M730	P745/S	G164-A (G164+G406)	G307	DPX5#22
T828-42-040VL/C	C300M-A2	5/32" (4.0)	E755P-A	D755P	M735P-E	P775P	G163	G307	DPX5#14
T828-42-048VL/C	C300M-A2	3/16" (4.8)	E766P-A	D766P	M766P-E	P766P	G163	G307	DPX5#14
T828-42-127KL/C	C301-A	1/2" (12.7)	E763-A	D763	M763	P763	G163	G307	DPX5#14
T828-45-032M		1/8" (3.2)	E762	D734/P	M0032R M0032L	P734/S	G169-A (G169+G409)	G307	DPX5#14
T828-45-048M		3/16" (4.8)	E761	D736/P	M0048R M0048L	P736/S	G169-A (G169+G409)	G307	DPX5#14
T828-45-064M		1/4" (6.4)	E760	D730/P	M0064R M0064L	P730/S	G169-A (G169+G409)	G307	DPX5#14
T828-45-032H		1/8" (3.2)	E762	D734/P	M0032R M0032L	P734/S	G169-A (G169+G409)	G307	DPX5#22
T828-45-048H		3/16" (4.8)	E761	D736Q	M0048R M0048L	P736/S	G169-A (G169+G409)	G307	DPX5#22
T828-45-064H		1/4" (6.4)	E760	D730Q	M0064R M0064L	P730/S	G169-A (G169+G409)	G307	DPX5#22
T828-45-032M/C	C300M-A2	1/8" (3.2)	E788-A	D754	M0032R M0032L	P754/S	G170-A (G170+G410)	G307	DPX5#14
T828-45-048M/C	C300M-A2	3/16" (4.8)	E787-A	D766	M0048R M0048L	P766/S	G170-A (G170+G410)	G307	DPX5#14
T828-45-064M/C	C300M-A2	1/4" (6.4)	E786-A	D745	M0064R M0064L	P745/S	G170-A (G170+G410)	G307	DPX5#14

									
MODEL	OPERATING PANEL	SUB-CLASS	NEEDLE PLATE	FEED DOG	NEEDLE CLAMP	PRESSER FOOT	HOOK	BOBBIN	NEEDLE
機 型	操作盒	規 格	針 板	下送具	針 釗	押 具	旋 梭	梭 子	針 號
T828-45-032H/C	C300M-A2	1/8" (3.2)	E788-A	D788D	M0032R M0032L	P754/S	G170-A (G170+G410)	G307	DPX5#22
T828-45-048H/C	C300M-A2	3/16" (4.8)	E787-A	D787D	M0048R M0048L	P766/S	G170-A (G170+G410)	G307	DPX5#22
T828-45-064H/C	C300M-A2	1/4" (6.4)	E786-A	D786D	M0064R M0064L	P745/S	G170-A (G170+G410)	G307	DPX5#22
T828-47-032LL		1/8" (3.2)	E791	D791	M734	P791/S	G161	G307	DPX5#11
T828-47-048LL		3/16" (4.8)	E790	D790	M736	P790/S	G161	G307	DPX5#11
T828-47-064LL		1/4" (6.4)	E789	D789	M730	P789/S	G161	G307	DPX5#11
T828-47-032L		1/8" (3.2)	E791	D791	M734	P791/S	G162-A (G162+G406)	G307	DPX5#11
T828-47-048L		3/16" (4.8)	E790	D790	M736	P790/S	G162-A (G162+G406)	G307	DPX5#11
T828-47-064L		1/4" (6.4)	E789	D789	M730	P789/S	G162-A (G162+G406)	G307	DPX5#11
T828-47-032LL/C	C300M-A2	1/8" (3.2)	E794-A	D794	M734	P791A	G163	G307	DPX5#11
T828-47-048LL/C	C300M-A2	3/16" (4.8)	E793-A	D793	M736	P790A	G163	G307	DPX5#11
T828-47-064LL/C	C300M-A2	1/4" (6.4)	E792-A	D792	M730	P789A	G163	G307	DPX5#11
T828-47-032L/C	C300M-A2	1/8" (3.2)	E794-A	D794	M734	P791A	G164-A (G164+G406)	G307	DPX5#11
T828-47-048L/C	C300M-A2	3/16" (4.8)	E793-A	D793	M736	P790A	G164-A (G164+G406)	G307	DPX5#11
T828-47-064L/C	C300M-A2	1/4" (6.4)	E792-A	D792	M730	P789A	G164-A (G164+G406)	G307	DPX5#11
T828-48-032L		1/8" (3.2)	E791	D791	M0032R M0032L	P791/S	G169-A (G169+G409)	G307	DPX5#11
T828-48-048L		3/16" (4.8)	E790	D790	M0048R M0048L	P790/S	G169-A (G169+G409)	G307	DPX5#11
T828-48-064L		1/4" (6.4)	E789	D789	M0064R M0064L	P789/S	G169-A (G169+G409)	G307	DPX5#11

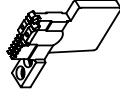
規格件表 CONVERSION CHART

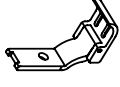
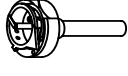
									
MODEL	OPERATING PANEL	SUB-CLASS	NEEDLE PLATE	FEED DOG	NEEDLE CLAMP	PRESSER FOOT	HOOK	BOBBIN	NEEDLE
機 型	操作盒	規 格	針 板	下送具	針 釧	押 具	旋 梭	梭 子	針 號
T828-48-032L/C	C300M-A2	1/8"(3.2)	E794-A	D794	M0032R M0032L	P791A	G170-A (G170+G410)	G307	DPX5#11
T828-48-048L/C	C300M-A2	3/16"(4.8)	E793-A	D793	M0048R M0048L	P790A	G170-A (G170+G410)	G307	DPX5#11
T828-48-064L/C	C300M-A2	1/4"(6.4)	E792-A	D792	M0064R M0064L	P789A	G170-A (G170+G410)	G307	DPX5#11
T828-72-032ML		1/8"(3.2)	E762	D734/P	M734	P762/S	G165	G310	DPX5#14
T828-72-048ML		3/16"(4.8)	E761	D736/P	M736	P761/S	G165	G310	DPX5#14
T828-72-064ML		1/4"(6.4)	E760	D730/P	M730	P760/S	G165	G310	DPX5#14
T828-72-032HL		1/8"(3.2)	E762	D734/P	M734	P762/S	G165	G310	DPX5#22
T828-72-048HL		3/16"(4.8)	E761	D736Q	M736	P761/S	G165	G310	DPX5#22
T828-72-064HL		1/4"(6.4)	E760	D730Q	M730	P760/S	G165	G310	DPX5#22
T828-72-032M/C	C300M-A2	1/8"(3.2)	E788-A	D754	M734	P762/S	G168-A (G168+G411)	G310	DPX5#14
T828-72-048M/C	C300M-A2	3/16"(4.8)	E787-A	D766	M736	P761/S	G168-A (G168+G411)	G310	DPX5#14
T828-72-064M/C	C300M-A2	1/4"(6.4)	E786-A	D745	M730	P760/S	G168-A (G168+G411)	G310	DPX5#14
T828-72-032H/C	C300M-A2	1/8"(3.2)	E788-A	D788D	M734	P762/S	G168-A (G168+G411)	G310	DPX5#22
T828-72-048H/C	C300M-A2	3/16"(4.8)	E787-A	D787D	M736	P761/S	G168-A (G168+G411)	G310	DPX5#22
T828-72-064H/C	C300M-A2	1/4"(6.4)	E786-A	D786D	M730	P760/S	G168-A (G168+G411)	G310	DPX5#22
T828-72-064HL/C	C300M-A2	1/4"(6.4)	E786-A	D786D	M730	P760/S	G168-A (G168+G411)	G310	DPX5#22
T828-75-032M		1/8"(3.2)	E762	D734/P	M0032R M0032L	P762/S	G166-A (G166+G407)	G310	DPX5#14
T828-75-048M		3/16"(4.8)	E761	D736/P	M0048R M0048L	P761/S	G166-A (G166+G407)	G310	DPX5#14

									
MODEL	OPERATING PANEL	SUB-CLASS	NEEDLE PLATE	FEED DOG	NEEDLE CLAMP	PRESSER FOOT	HOOK	BOBBIN	NEEDLE
機 型	操作盒	規 格	針 板	下送具	針 釗	押 具	旋 梭	梭 子	針 號
T828-75-064M		1/4*(6.4)	E760	D730/P	M0064R M0064L	P760/S	G166-A (G166+G407)	G310	DPX5#14
T828-75-032H		1/8*(3.2)	E762	D734/P	M0032R M0032L	P762/S	G166-A (G166+G407)	G310	DPX5#22
T828-75-048H		3/16*(4.8)	E761	D736Q	M0048R M0048L	P761/S	G166-A (G166+G407)	G310	DPX5#22
T828-75-064H		1/4*(6.4)	E760	D730Q	M0064R M0064L	P760/S	G166-A (G166+G407)	G310	DPX5#22
T828-75-032M/C	C300M-A2	1/8*(3.2)	E788-A	D754	M0032R M0032L	P762/S	G168-A1 (G168+G408)	G310	DPX5#14
T828-75-048M/C	C300M-A2	3/16 (4.8)	E787-A	D766	M0048R M0048L	P761/S	G168-A1 (G168+G408)	G310	DPX5#14
T828-75-064M/C	C300M-A2	1/4*(6.4)	E786-A	D745	M0064R M0064L	P760/S	G168-A1 (G168+G408)	G310	DPX5#14
T828-75-032H/C	C300M-A2	1/8*(3.2)	E788-A	D788D	M0032R M0032L	P762/S	G168-A1 (G168+G408)	G310	DPX5#22
T828-75-048H/C	C300M-A2	3/16*(4.8)	E787-A	D787D	M0048R M0048L	P761/S	G168-A1 (G168+G408)	G310	DPX5#22
T828-75-064H/C	C300M-A2	1/4*(6.4)	E786-A	D786D	M0064R M0064L	P760/S	G168-A1 (G168+G408)	G310	DPX5#22

GTA42-A

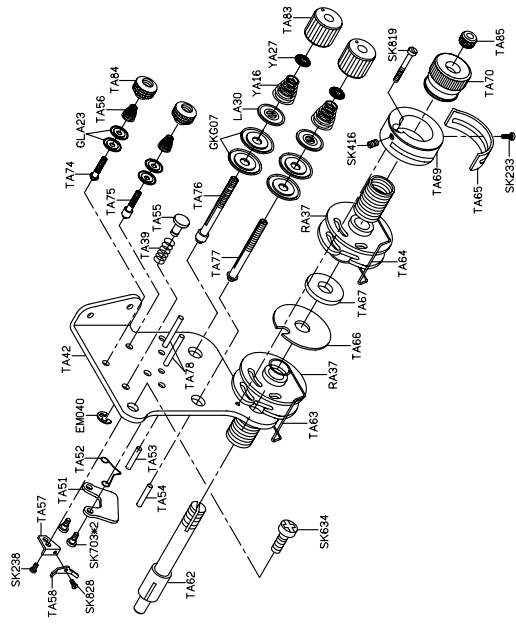

GTA91-A (FOR T828-47/48)

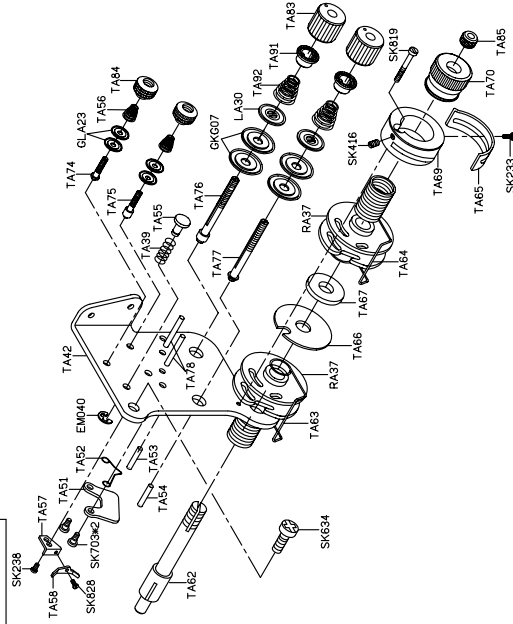

MODEL	T828-42		T828-47		T828-72	
	M	H	L	M	H	
PARTS NO.	TB26	TB26	TB106-A	TB26	TB26	TB26
	TB27-A	TB27-A		TB27-A	TB27-A	TB27-A
	TB40	TB90	TB98	TB96	TB96	TB96

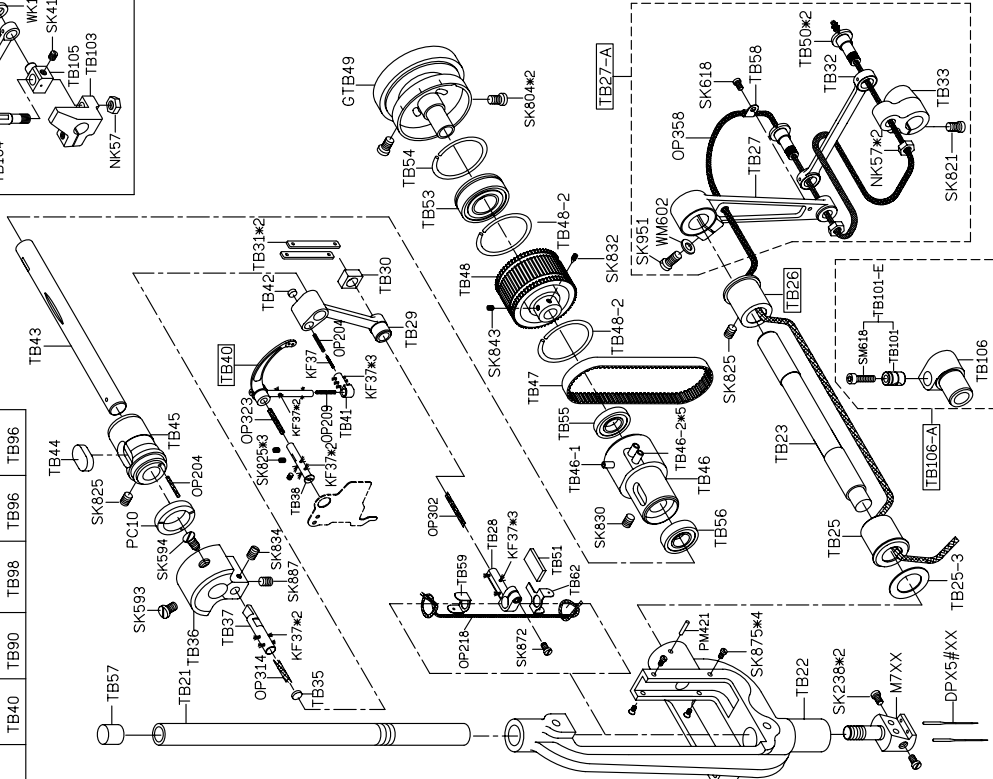
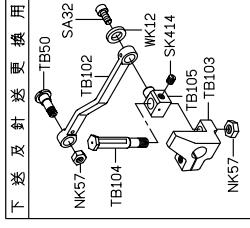

PARTS LIST FOR TB GROUP

PARTS LIST FOR TC GROUP

MODEL	T828-45		T828-48		T828-75	
	M	H	L	M	M	H
PARTS NO.	TB26	TB26	TB106-A	TB26	TB26	TB26
	TB27-A	TB27-A	TB27-A	TB27-A	TB27-A	TB27-A
	TB90	TB90	TB98	TB97	TB97	TB97

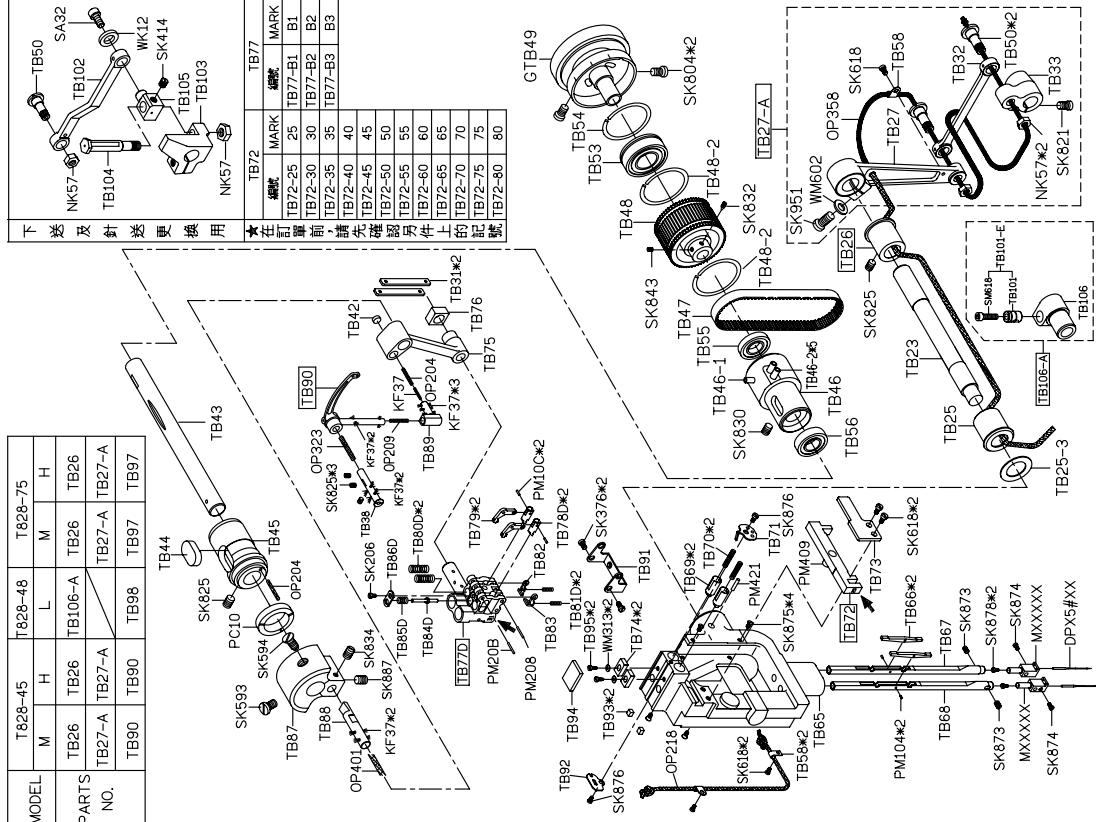

MODEL	T828-42		T828-45		T828-72		T828-75	
	M	H	M	H	M	H	M	H
PARTS NO.	TC50	TC50	TC50	TC50	TC79	TC79	TC79	TC79
	TC66	TC81	TC66	TC81	TC82	TC82	TC82	TC82
	TC69	TC69	TC69	TC69	TC78	TC78	TC78	TC78
	TC70	TC85	TC70	TC85	TC70	TC70	TC70	TC70

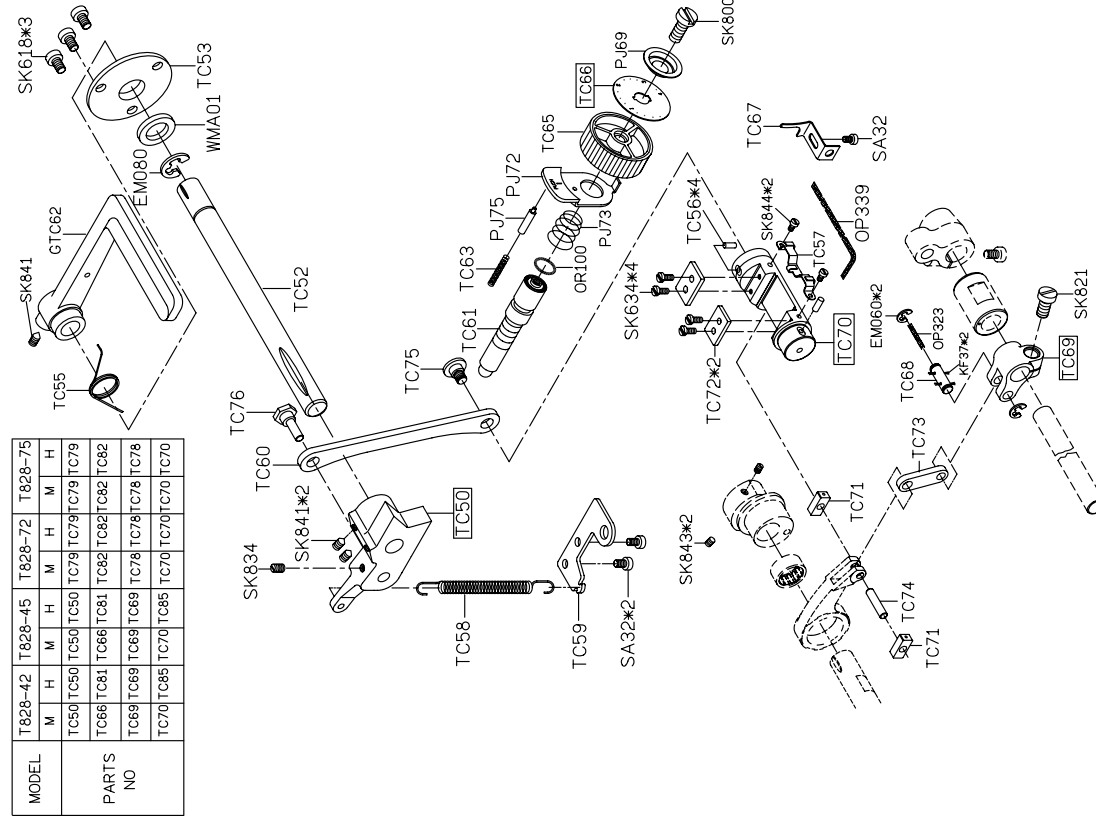

MODEL	T828-42/45	T828-72/75
	M H	M H
PARTS NO	TE06 TE07 TE15 TE18 TE52 TE53	TE56 TE57 TE58 TE59 TE62 TE63 TE66

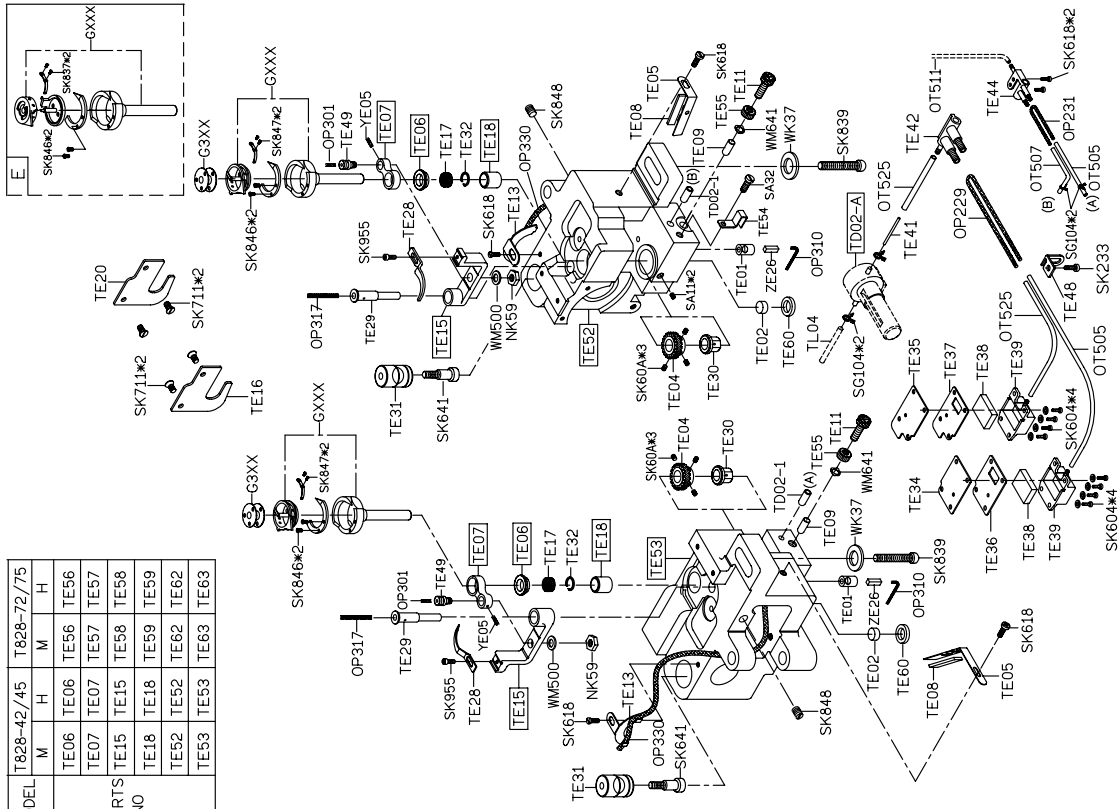

MODEL	T828-42/45	T828-47/48	T828-72/75
	M L H	M L H	M L H
PARTS NO	TD01 TD02 TD03 TD04 TD19	TD01 TD02 TD03 TD04 TD19 TD28 TD29	TD01 TD02 TD03 TD04 TD19 TD28 TD29

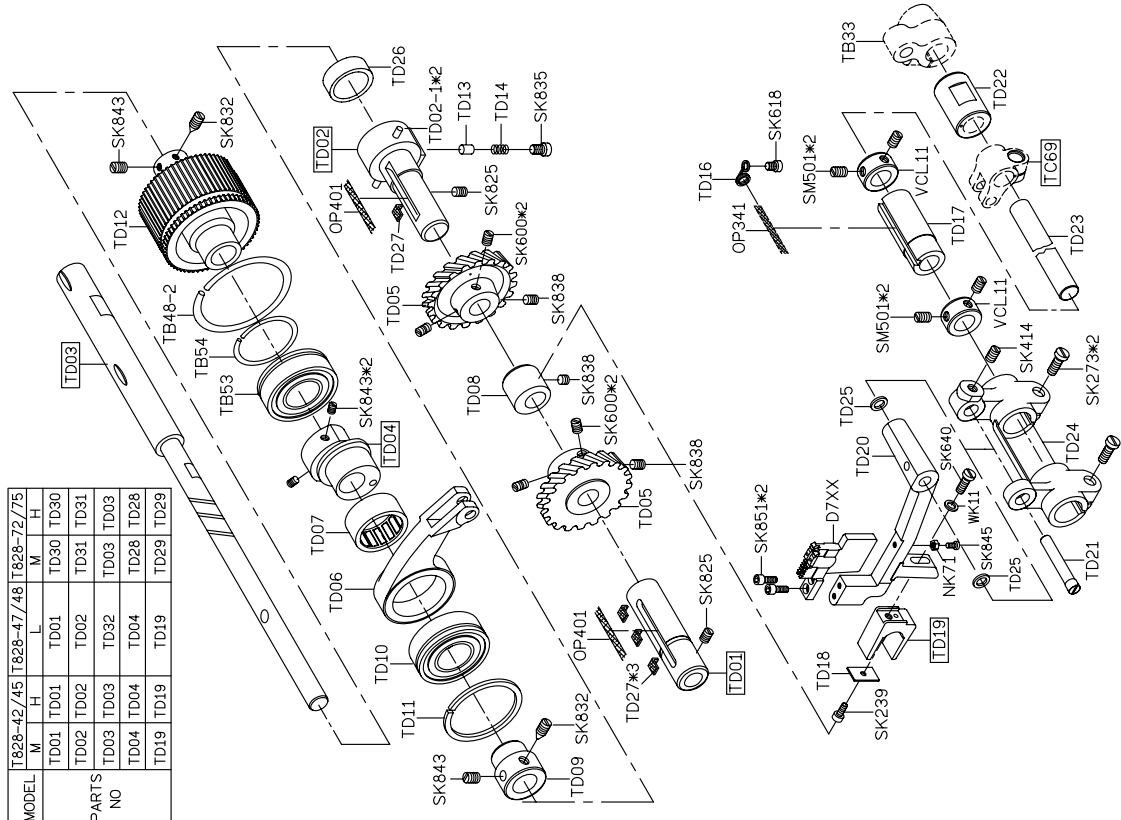

PARTS LIST FOR TI GROUP

PARTS LIST FOR TL GROUP

MODEL	T828-42/45	T828-47/48	T828-72/75
PARTS NO.	TI07	TI45	TI07

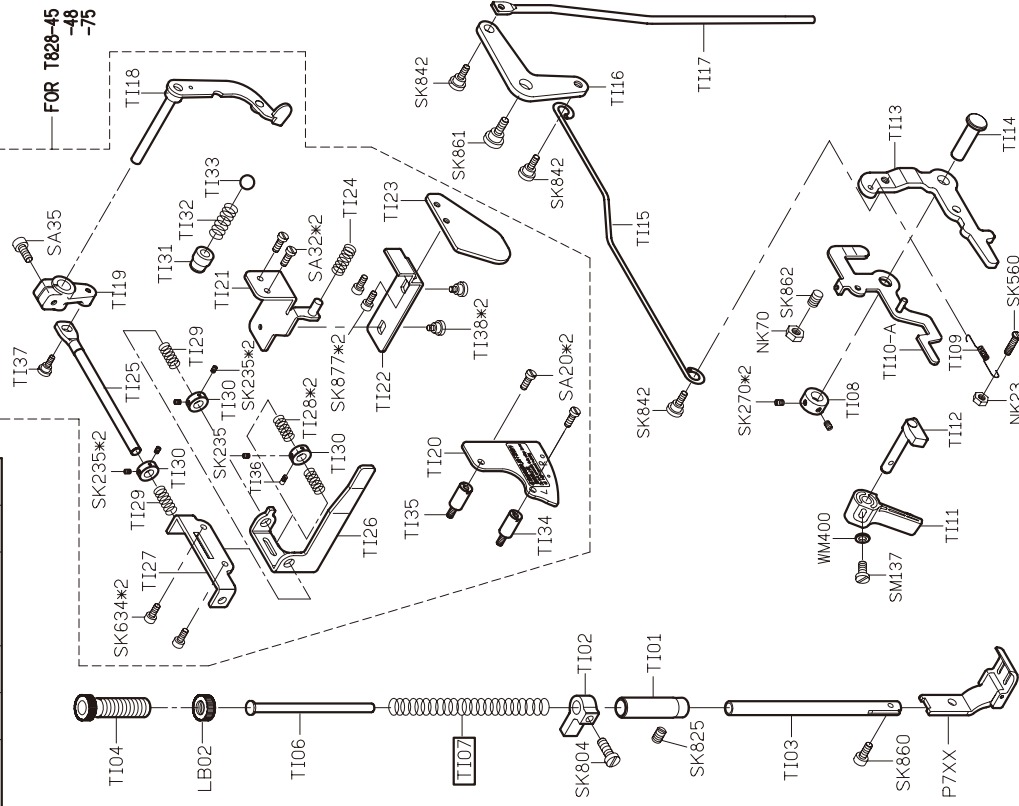

MODEL	T828-42/72	T828-45/75
PARTS NO.	TL05	TL31

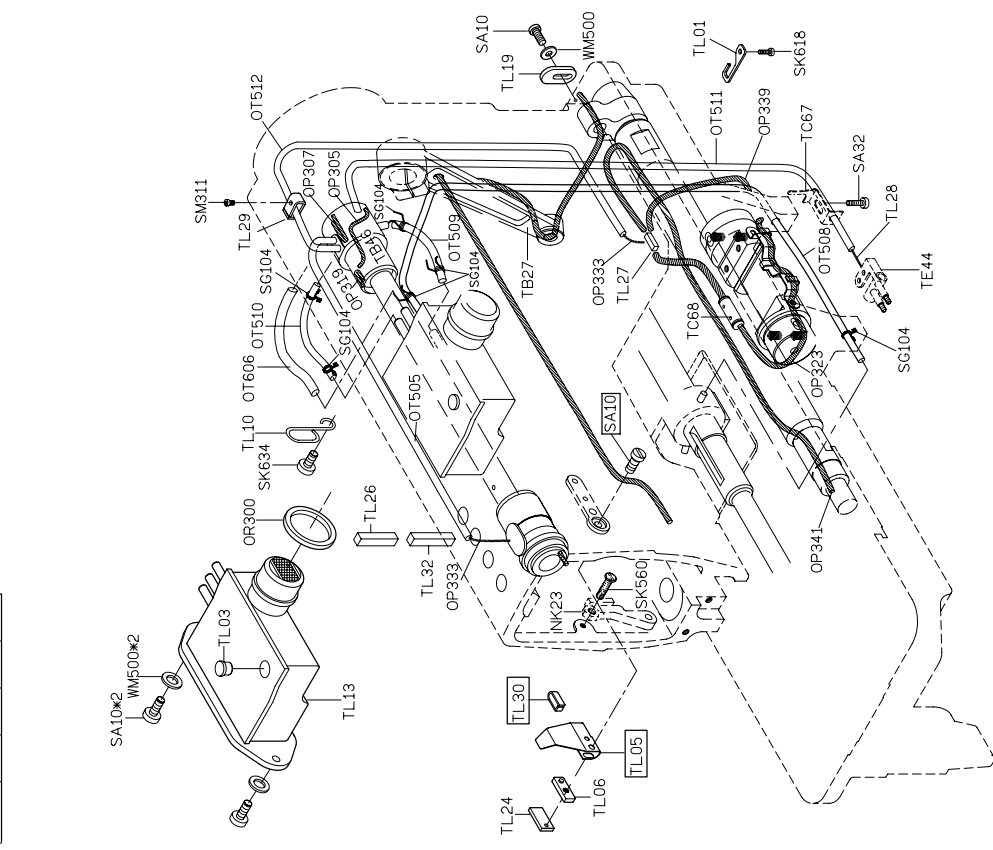

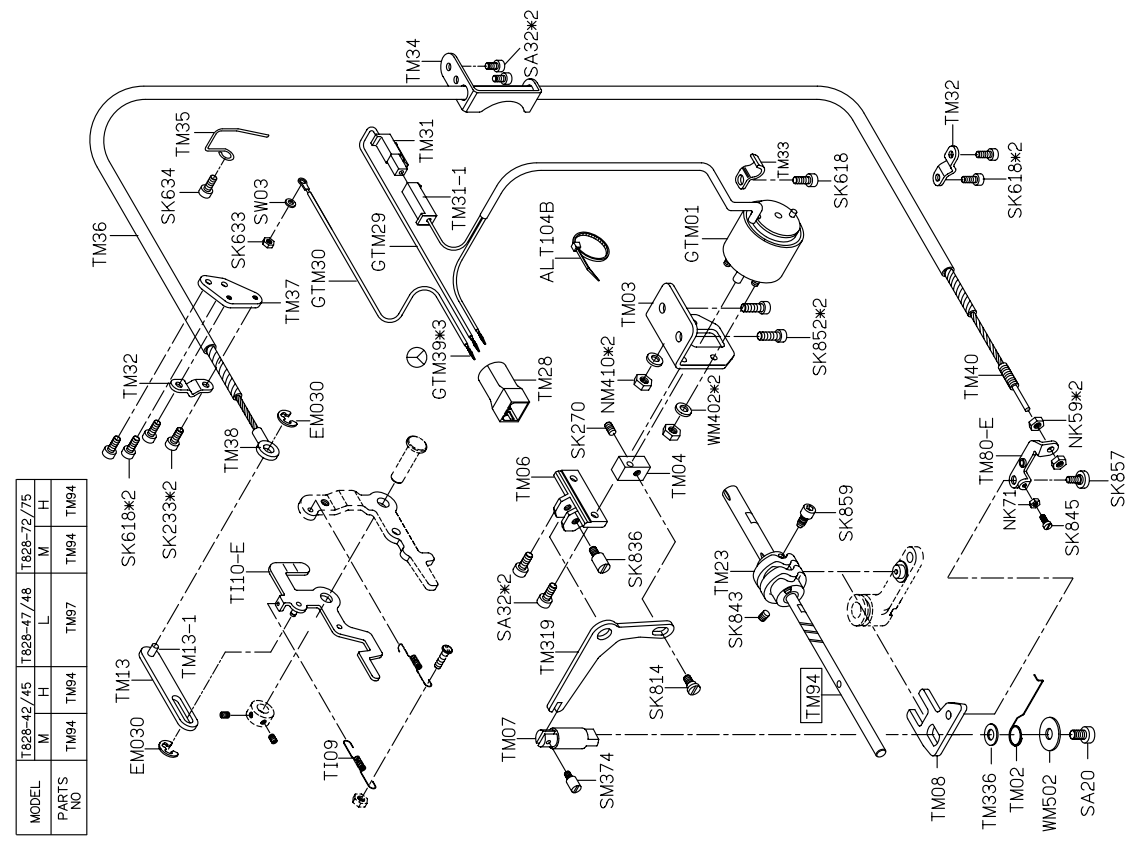
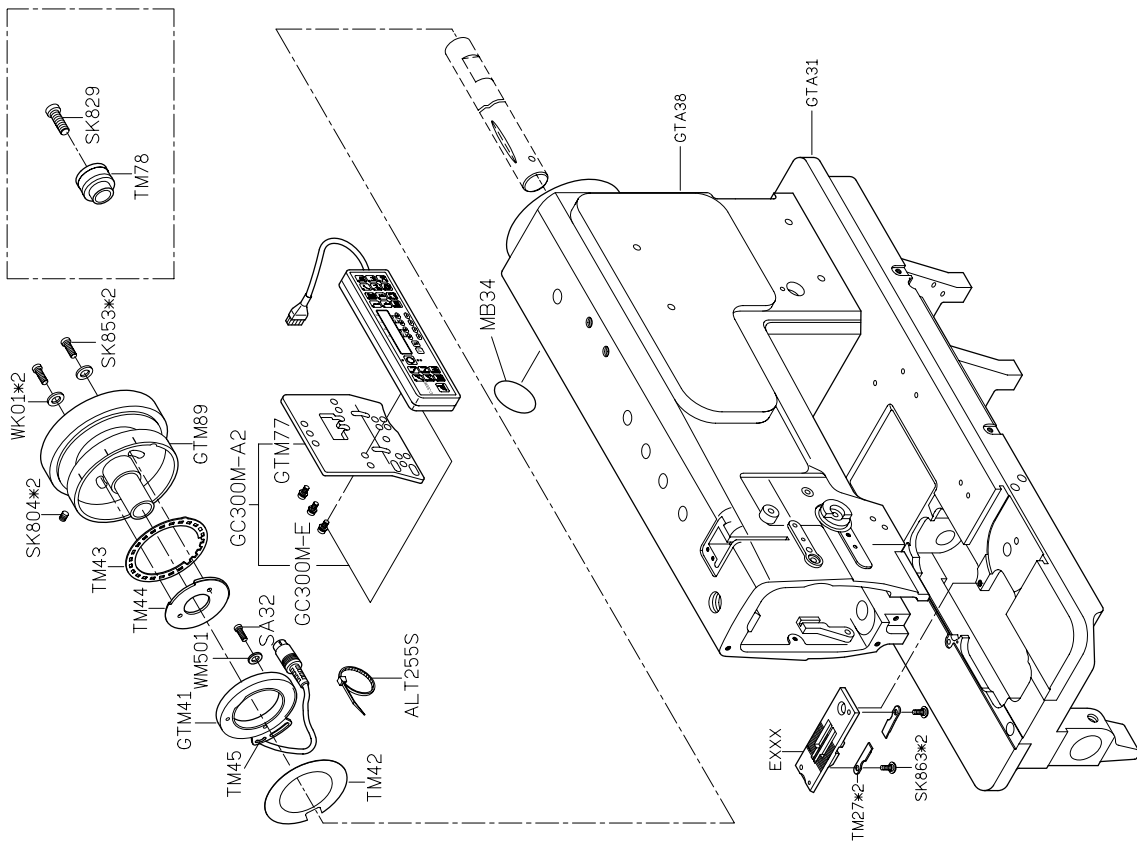

MODEL	T828-42/45	T828-47/48	T828-72/75
M	H	L	H
PARTS NO.	TM94	TM94	TM97
	TM94	TM94	TM94

GYU66-A1

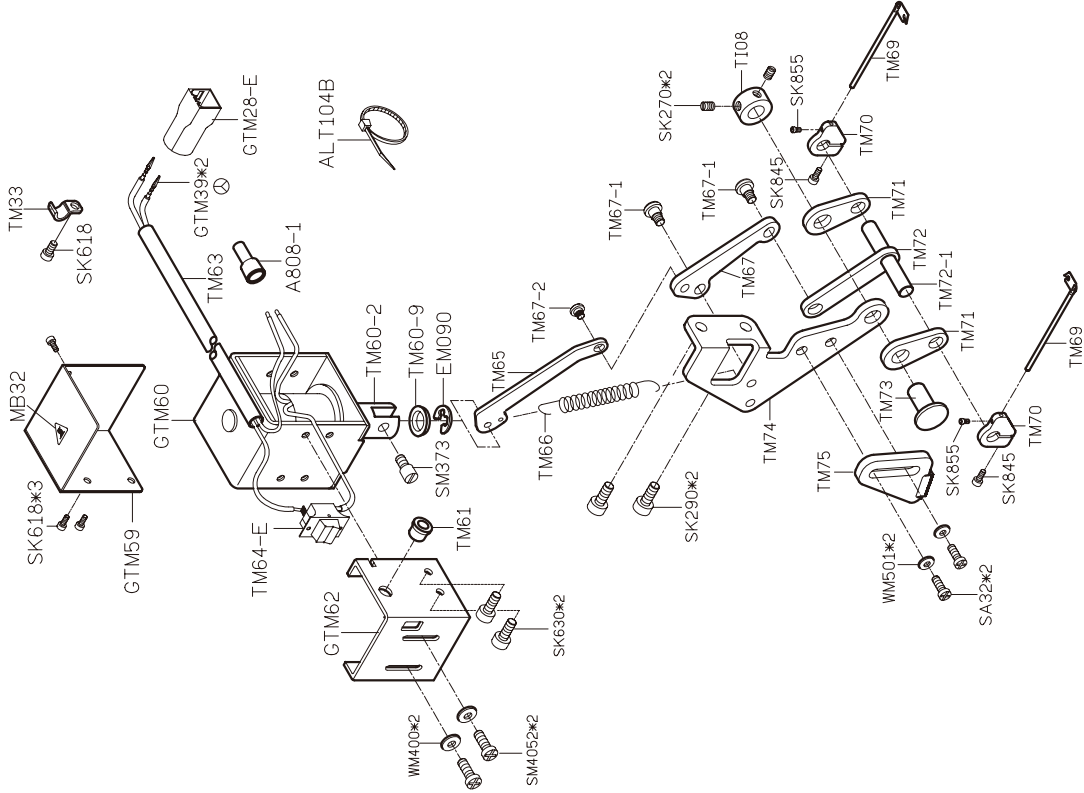
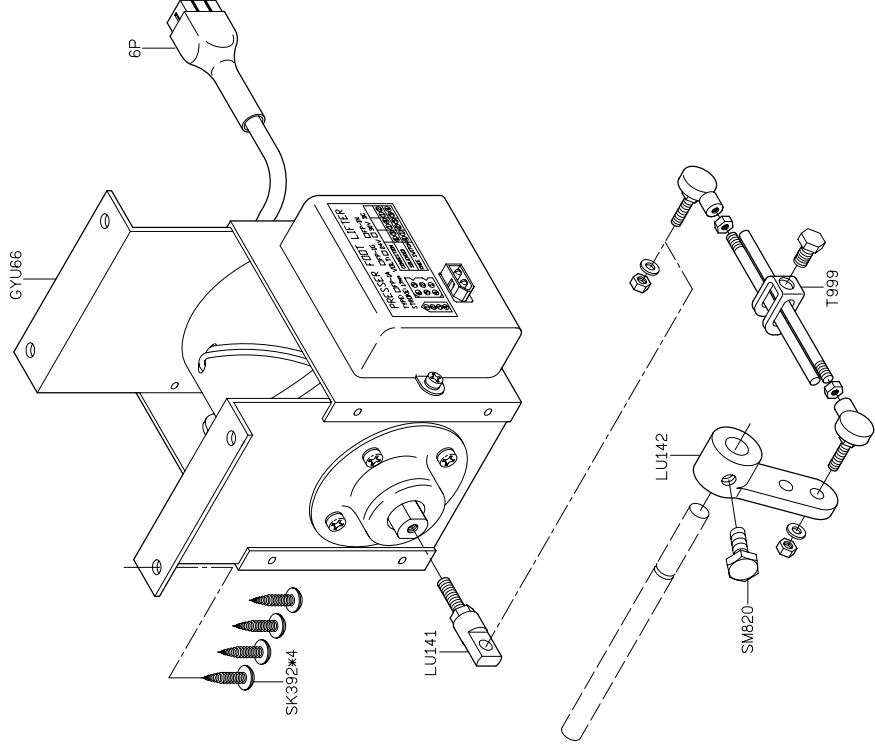

PARTS LIST FOR TM GROUP

PARTS LIST FOR TM GROUP

PARTS LIST FOR TM GROUP

PARTS LIST FOR TN GROUP

GYU67-A1

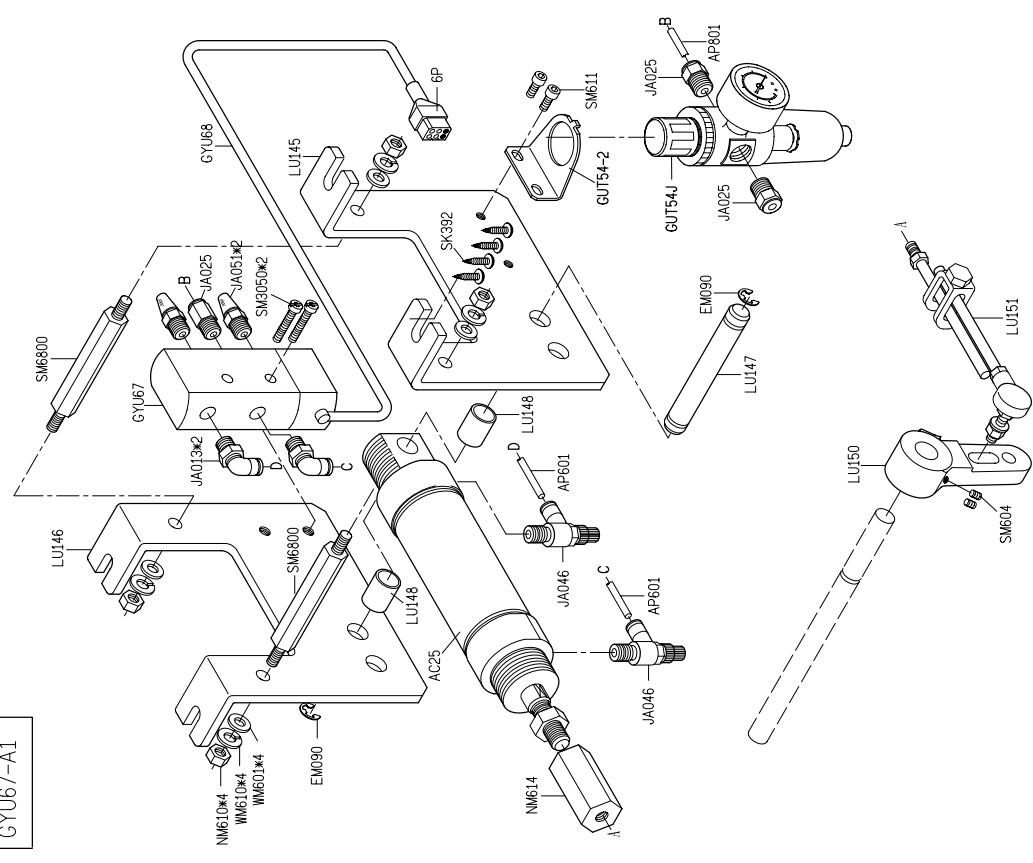
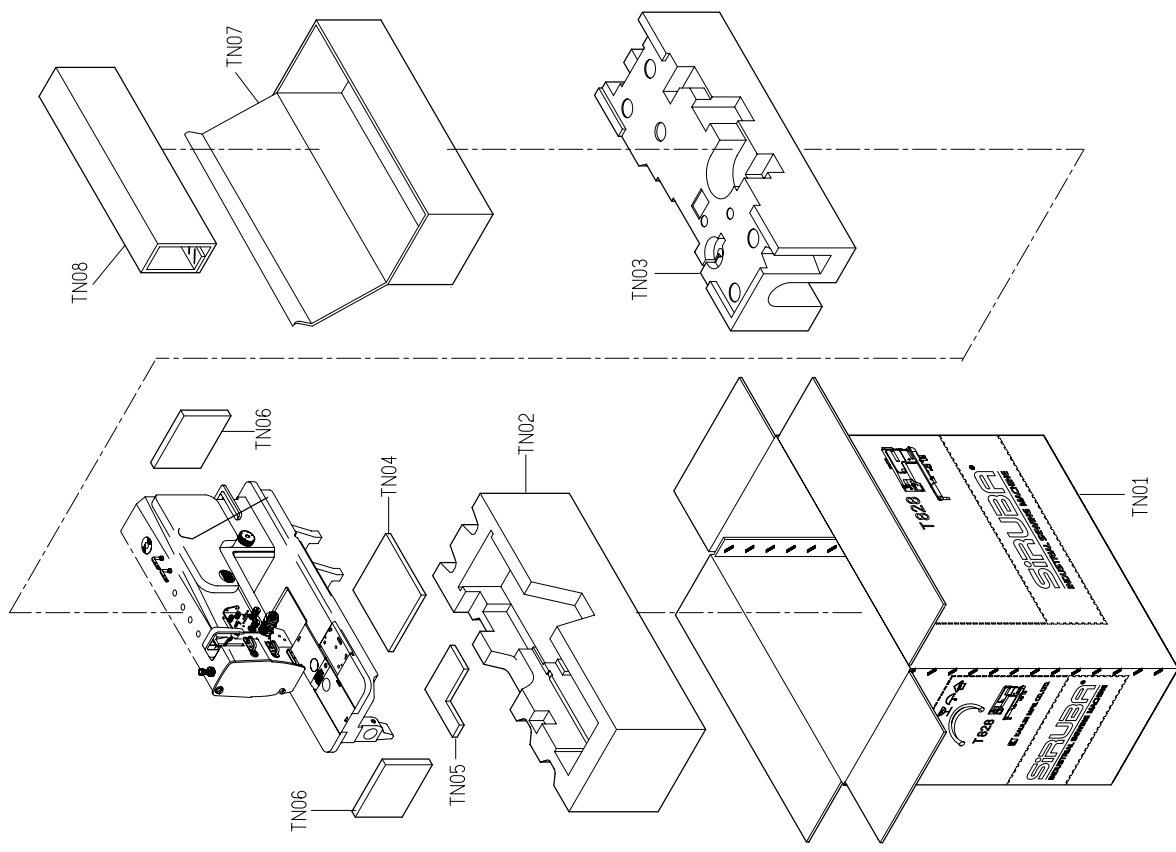

PY11-3

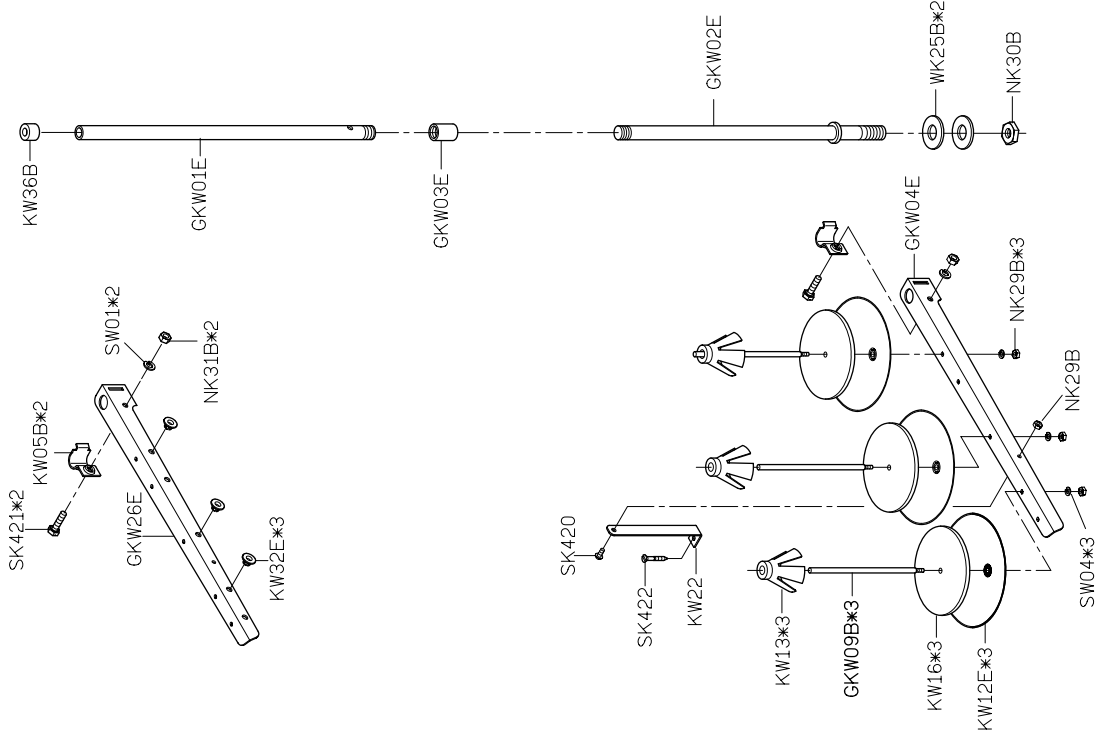

GTU07-A 手輪護蓋

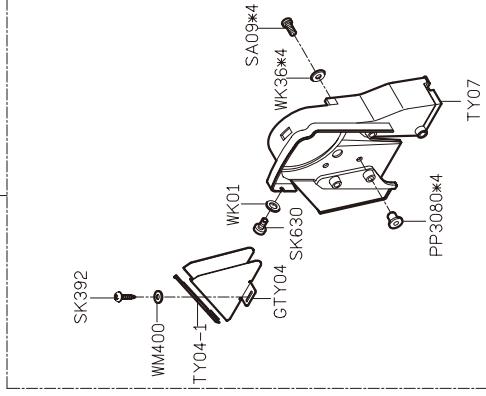

GTU08-A 油盤

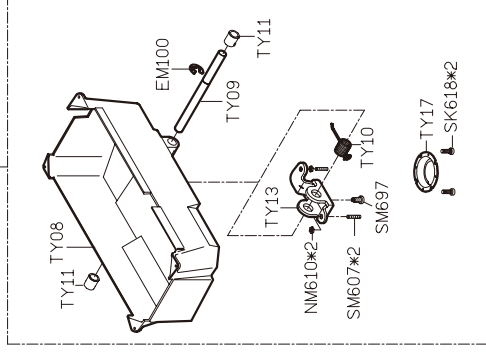



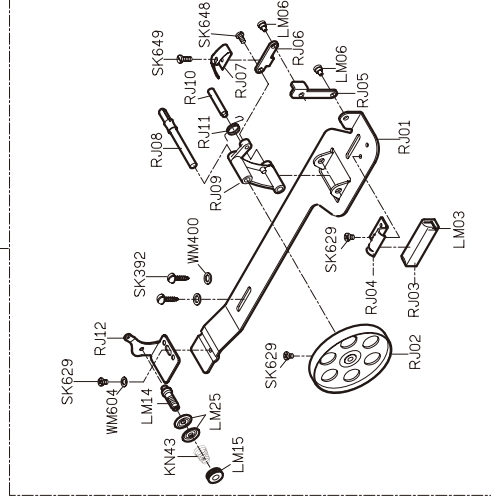



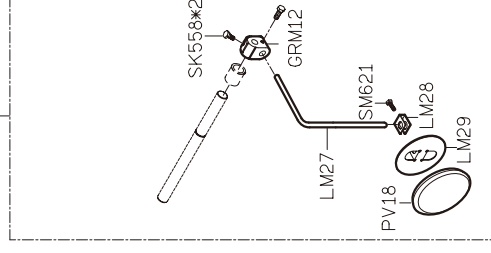

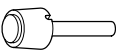





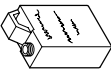





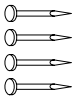

RJ01-A 繞線器

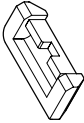
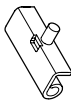

LM27-A 腳弓



01 說明書		14 押具提昇軸		15*4 防震橡膠墊		16 油壺		GMY01 防塵罩	
MY11 六角板手		MY13 六角板手		GXXX*4 梭子		KY02-A 油罐		KY03 油壺	
KY09 開口板手		KY10 六角板手		KY16 一字起子		KY17 一字起子		GKY26F 工具袋	
KZ03 乾燥劑		PY05*4 鐵釘		LY01 開口板手		LY02 木頭桿		針*4	
LY04*2 後鈕墊		LY05*2 後鈕		☆103D 切刀		TY02 零件圖		☆TP156 使用說明書	

MODEL	T828-42		T828-45		T828-47	T828-48		T828-72		T828-75	
	M	H	M	H	L	L	M	H	M	H	
PARTS NO	G307	G307	G307	G307	G307	G307	G310	G310	G310	G310	G310
	KY17	KY17	KY14	KY14	KY17	KY14	KY17	KY17	KY17	KY14	KY14
	DPX5#14	DPX5#22	DPX5#14	DPX5#22	DPX5#11	DPX5#11	DPX5#14	DPX5#22	DPX5#14	DPX5#14	DPX5#22



T828

高林股份有限公司 KAULIN MFG. CO., LTD.